

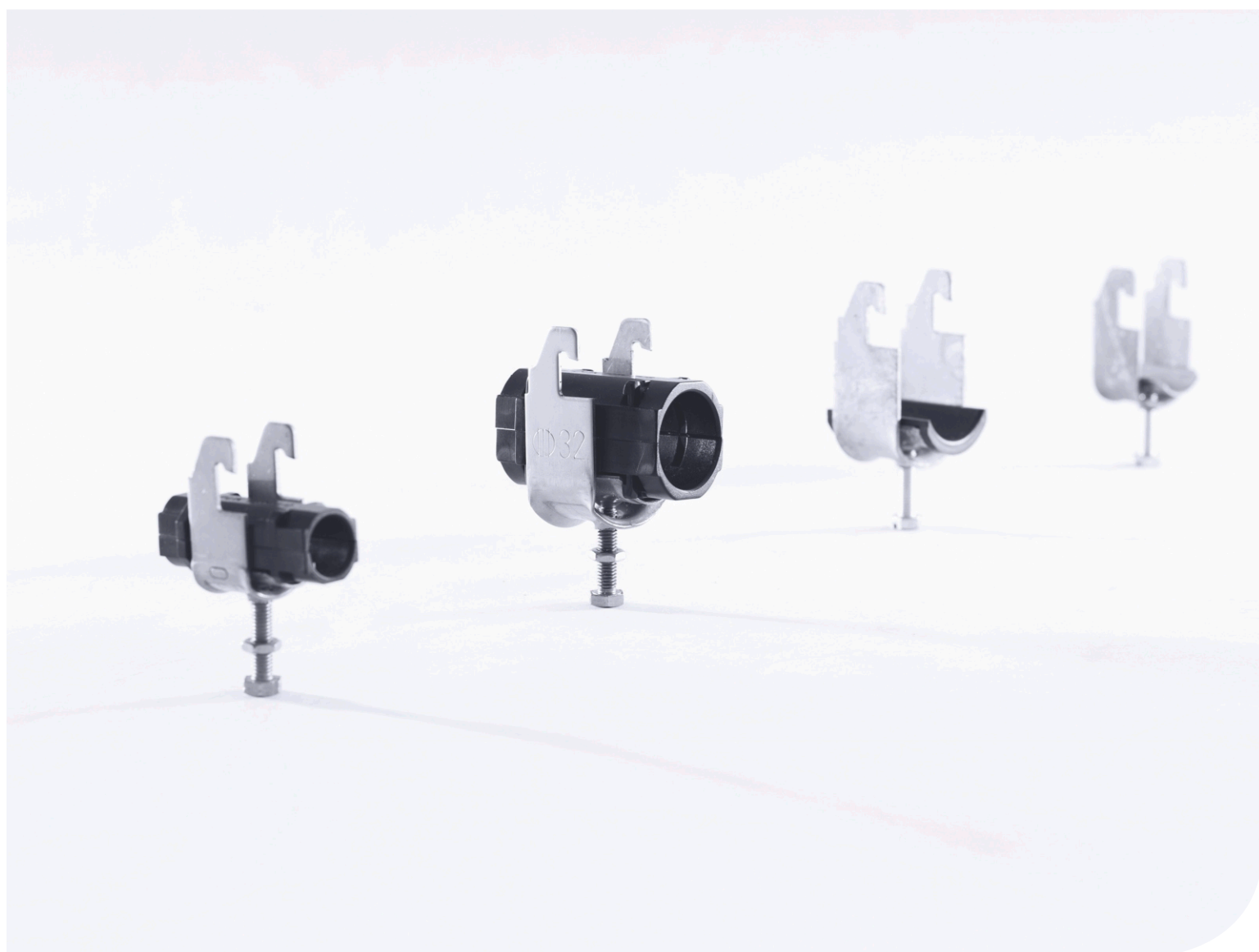

## Uchwyty kablowe - zastosowanie

### Informacja techniczna



## **EL-PUK Sp. z o.o.**

### **Siedziba główna i zakład produkcyjny Konstancynów Łódzki**

ul. Kościelna 15

95-050 Konstancynów Łódzki

Polska

Telefon: +48 42 211 88 01 Sekretariat  
+48 42 211 88 10 Dział Sprzedaży  
+48 42 211 88 25 Dział Ofert  
+48 42 211 88 26 Dział Budów  
+48 42 211 88 18 Dział Konstrukcyjny  
+48 42 211 88 27 Dział Marketingu

Fax: +48 42 211 88 04

[elpuk@elpuk.com.pl](mailto:elpuk@elpuk.com.pl)

### **Magazyn Katowice**

al. Różdzieńskiego 188

40-203 Katowice

Polska

Telefon: +48 691 111 585

+48 693 330 669

[katowice@elpuk.com](mailto:katowice@elpuk.com)

[marketing@elpuk.com](mailto:marketing@elpuk.com)

[www.elpuk.com.pl](http://www.elpuk.com.pl)

# Uchwyty kablowe

Uchwyty kablowe - zastosowanie [A05-A14](#)

---





# Uchwyty kablowe - zastosowanie

## Informacje techniczne

### AC Montaż uchwyty AC

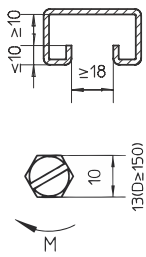
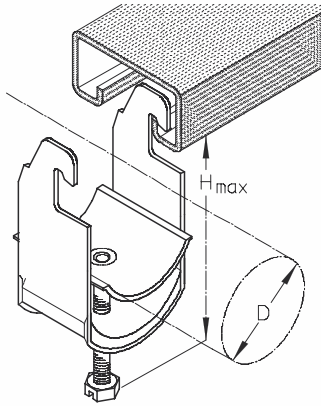

**A 41 / KHA 41**

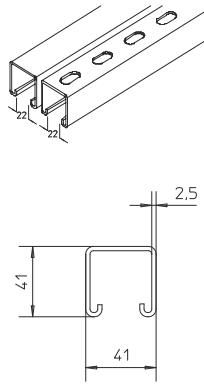

**A 2 / KHA 2**

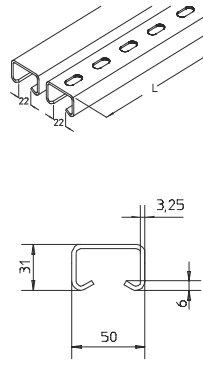

**A 4 / KHA 4**

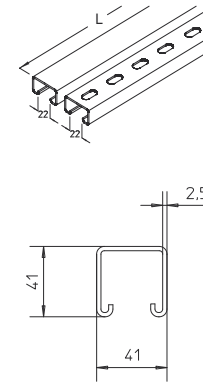

**A 9 / KHA 9**

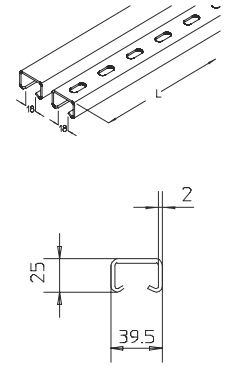

**A 8 / KHA 8**

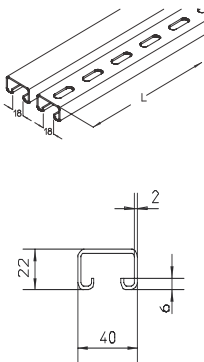

**A 7 / KHA 7**

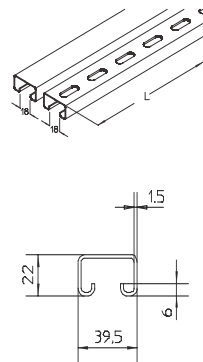

**U-03 / UL-03**

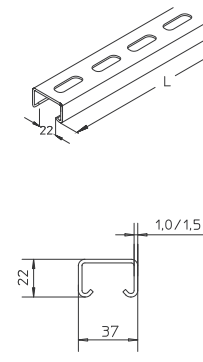

**U-13 / UL-13**

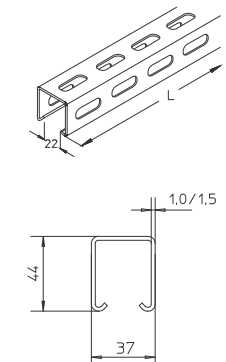

**G 50**

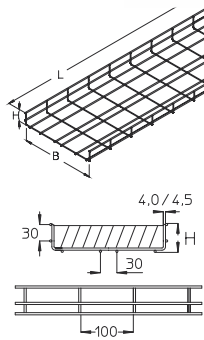

**G 100**

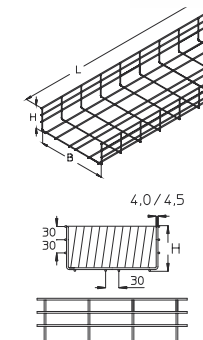

**GI**

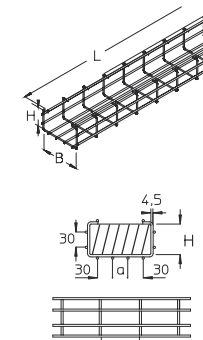

**STU 50**

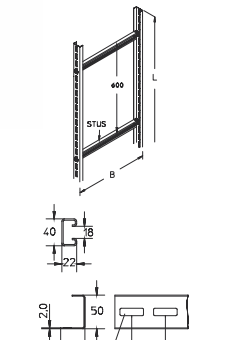

**STU 60**

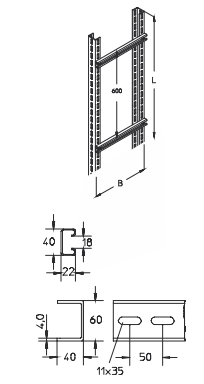

**STU 62**

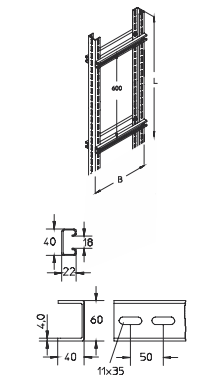

**STU 81**

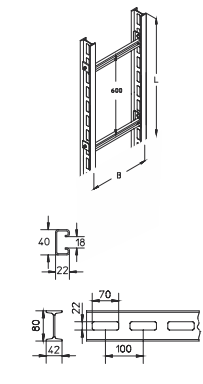

**STU 82**

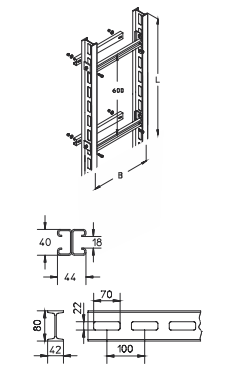

# Uchwyty kablowe - zastosowanie

## Informacje techniczne

### AC-IW Montaż uchwyty AC-IW

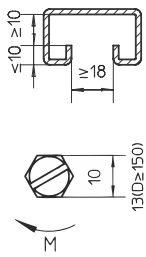
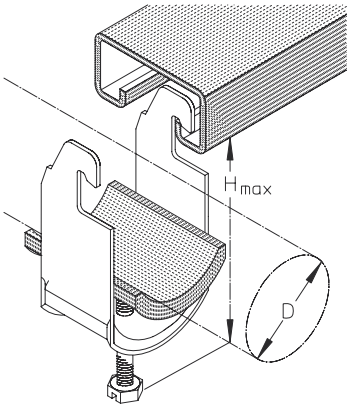

**A 41 / KHA 41**

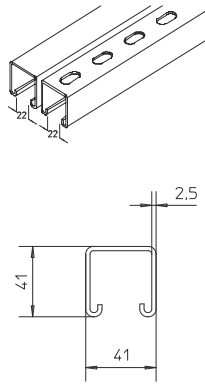

**A 2 / KHA 2**

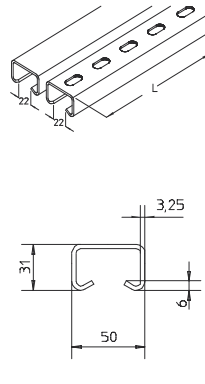

**A 4 / KHA 4**

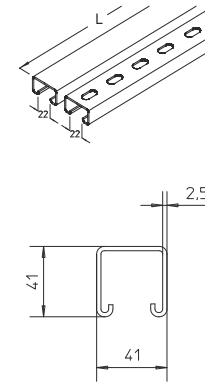

**A 9 / KHA 9**

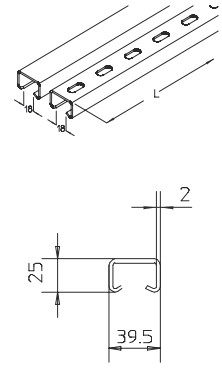

**A 8 / KHA 8**

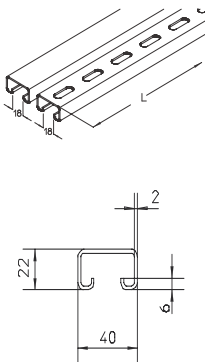

**A 7 / KHA 7**

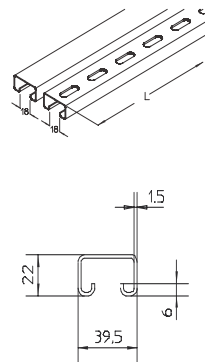

**U-03 / UL-03**

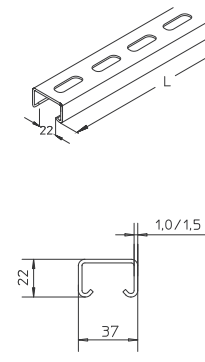

**U-13 / UL-13**

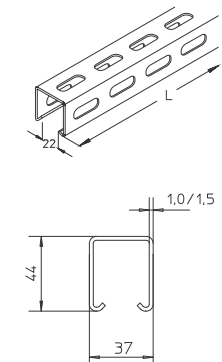

**G 50**

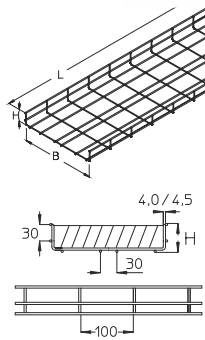

**G 100**

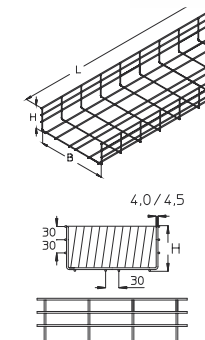

**GI**

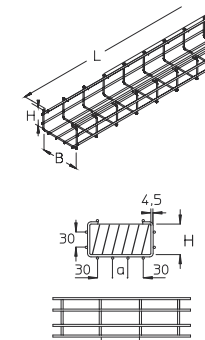

**STU 50**

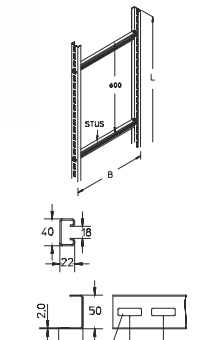

**STU 60**

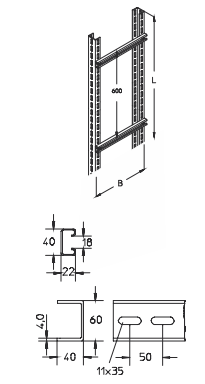

**STU 62**

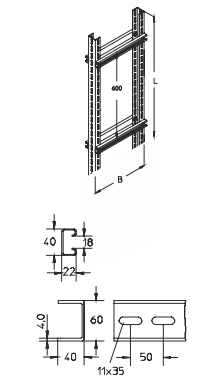

**STU 81**

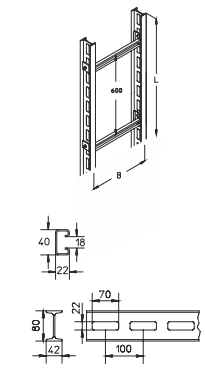

**STU 82**

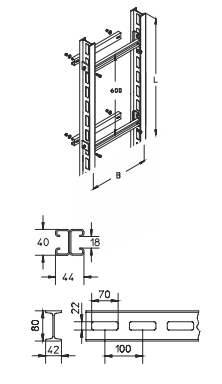

# Uchwyty kablowe - zastosowanie

## Informacje techniczne

### H Montaż uchwyty H

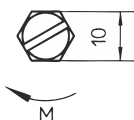
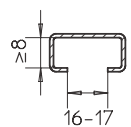
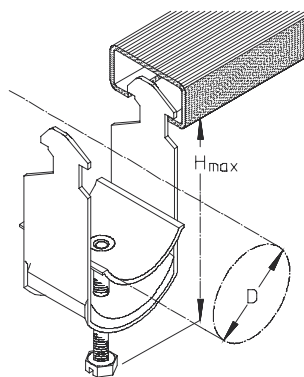

**B 7 / KHB 7**

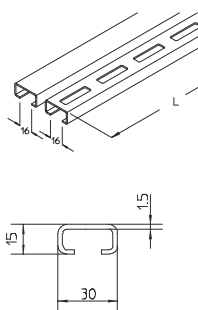

**LGG 60**

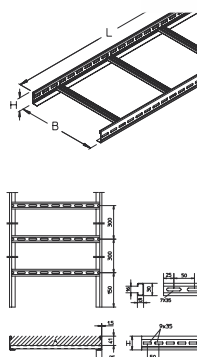

**LGGS 60**

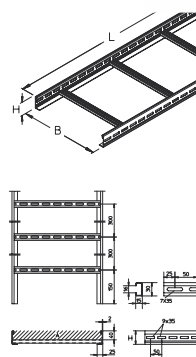

**LGG 100**

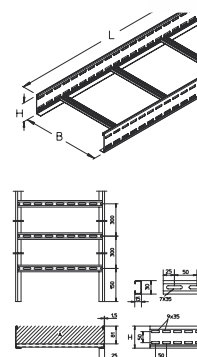

**LGGS 100**

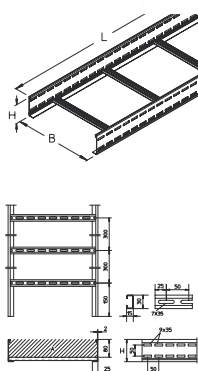

**WPL 120**

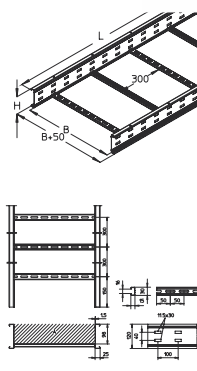

**WPL 150**

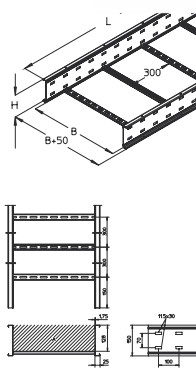

# Uchwyty kablowe - zastosowanie

## Informacje techniczne

### H-IW Montaż uchwyty H-IW

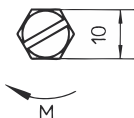
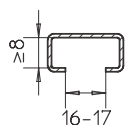
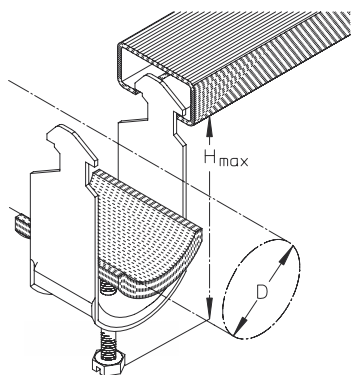

### B 7 / KHB 7

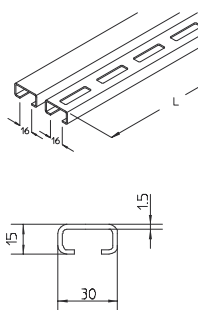

### LGG 60

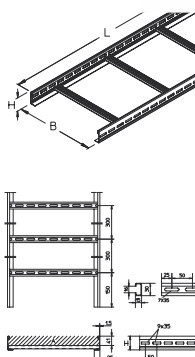

### LGGS 60

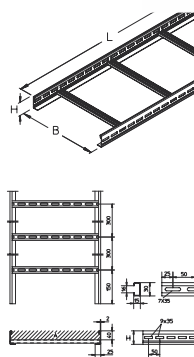

### LGG 100

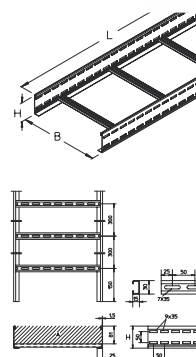

### LGGS 100

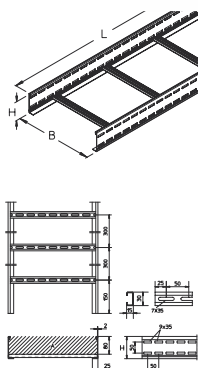

### WPL 120

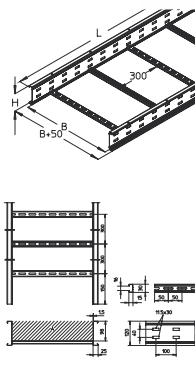

### WPL 150

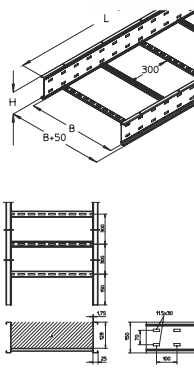



# Uchwyty kablowe - zastosowanie

## Informacje techniczne

### B Montaż uchwyty B

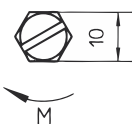
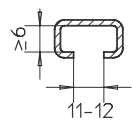
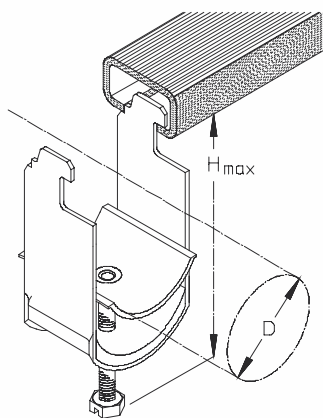

### B 3

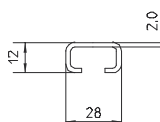
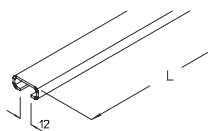

### B 6

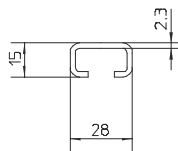
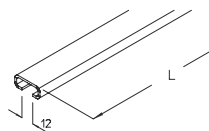

### LG 50

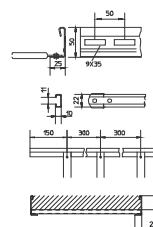
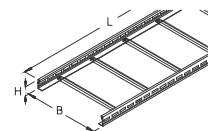

### LG 60

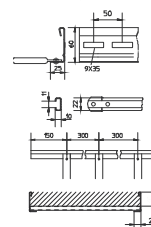
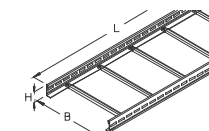

### LGS 60

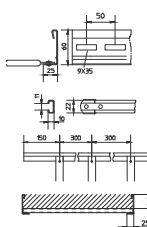
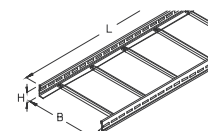

### LG 100

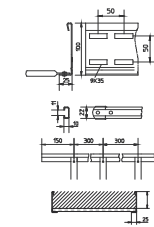
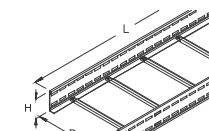

# Uchwyty kablowe - zastosowanie

## Informacje techniczne

### HB Montaż uchwyty HB

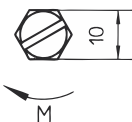
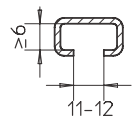
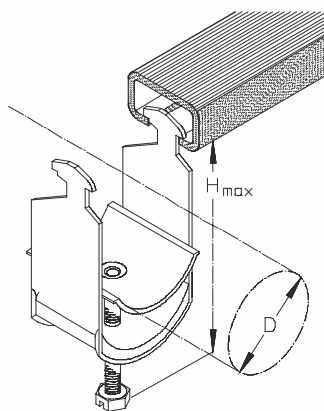

**B 3**

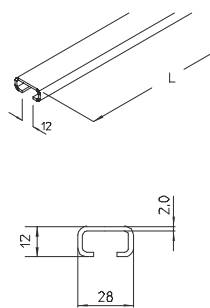

**B 6**

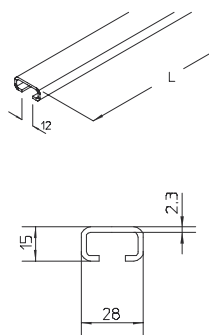

**LG 50**

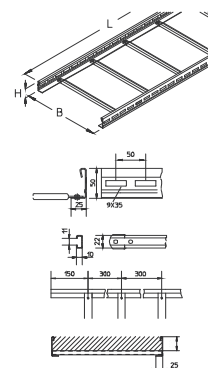

**LG 60**

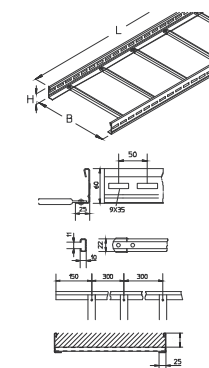

**LGS 60**

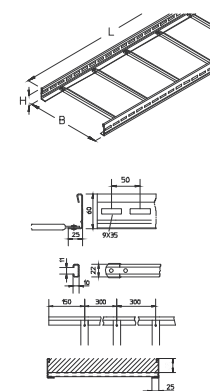

**LG 100**

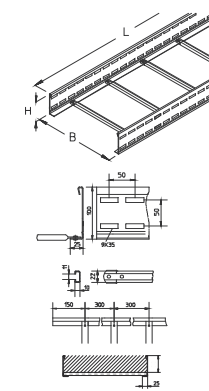

# Uchwyty kablowe - zastosowanie

## Informacje techniczne

### HB-IW Montaż uchwyty HB-IW

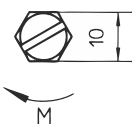
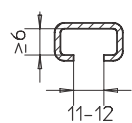
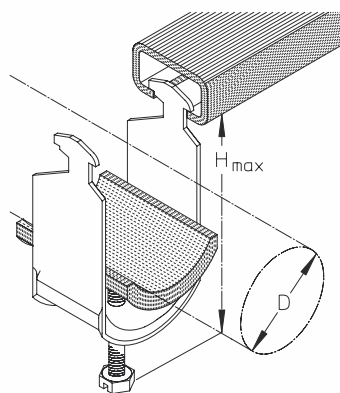

#### B 3

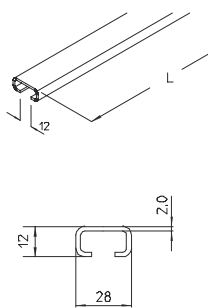

#### B 6

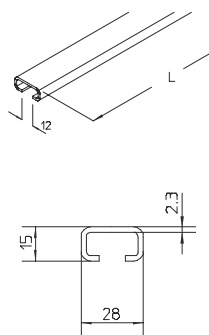

#### LG 50

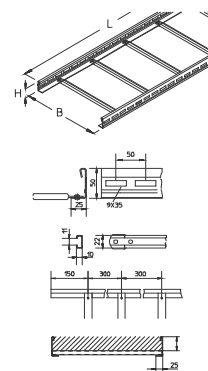

#### LG 60

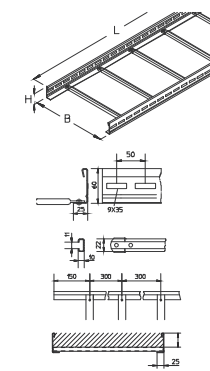

#### LGS 60

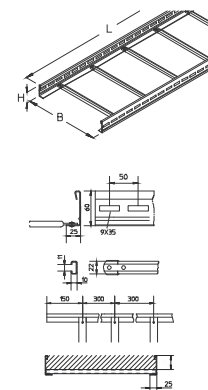

#### LG 100

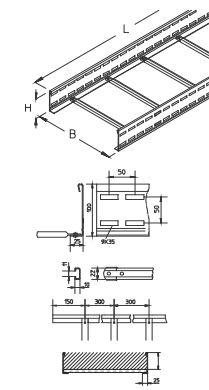

# Uchwyty kablowe - zastosowanie

## Informacje techniczne

### ACF-E Montaż uchwyty ACF-E

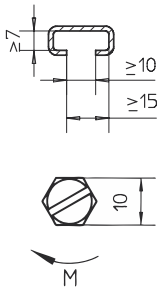
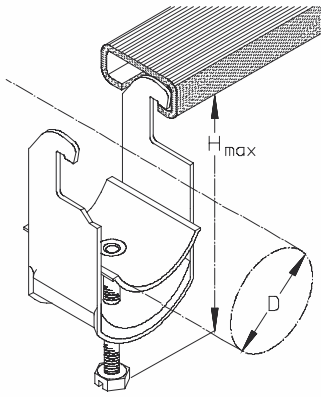

**A 41 / KHA 41**

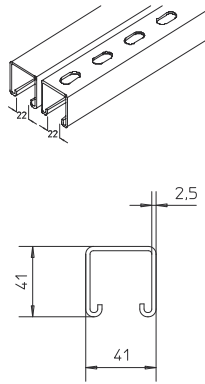

**A 2 / KHA 2**

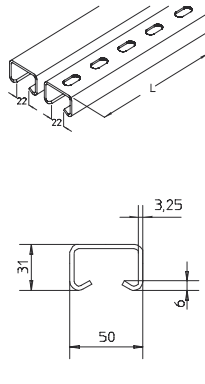

**A 4 / KHA 4**

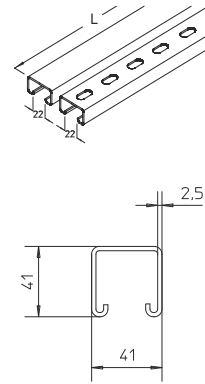

**A 7 / KHA 7**

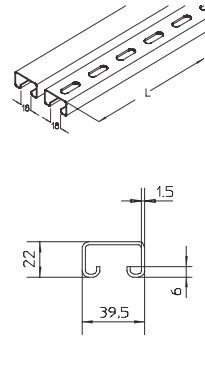

**A 8 / KHA 8**

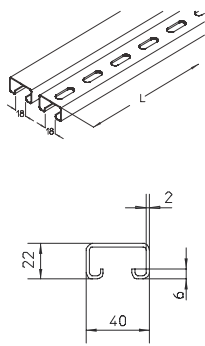

**A 9 / KHA 9**

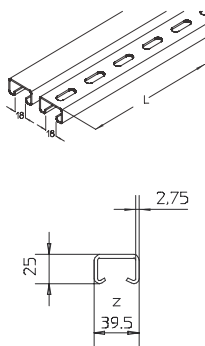

**B3**

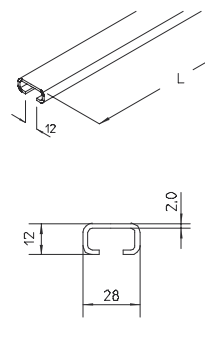

**B 6**

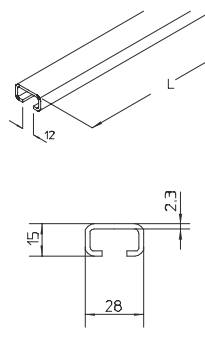

**LG 50**

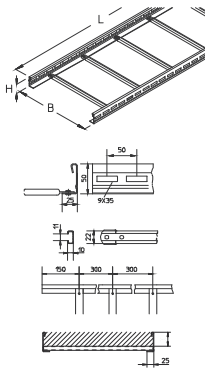

**LG 60**

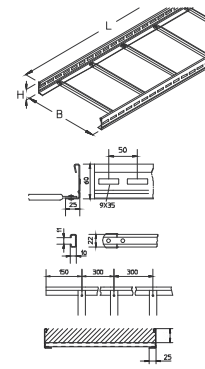

**LGS 60**

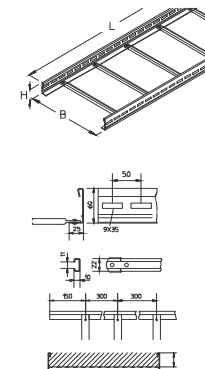

**LG 100**

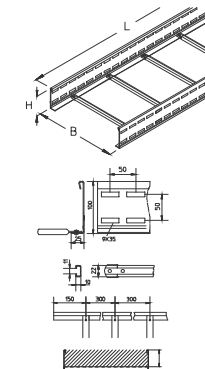

# Uchwyty kablowe - zastosowanie

## Informacje techniczne

### S Montaż uchwyty S

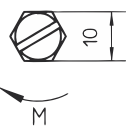
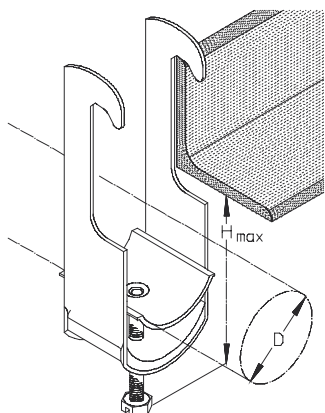

Rozmiar klucza SW 13  
Średnica D ≥ 150

### Kątownik

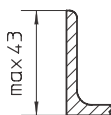

### S-IW Montaż uchwyty S-IW

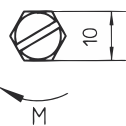
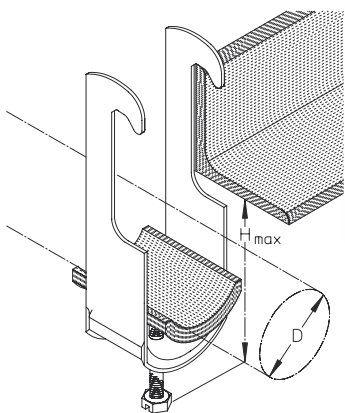

Rozmiar klucza SW 13  
Średnica D ≥ 150

### Kątownik

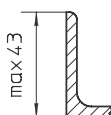

### U Montaż uchwyty U

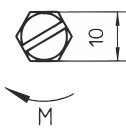
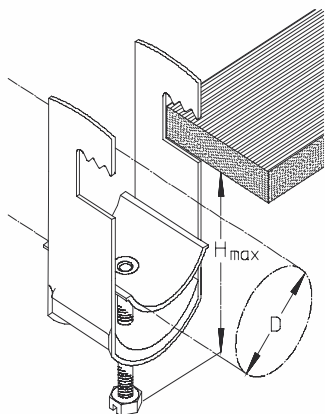

Rozmiar klucza SW 13  
Średnica D ≥ 150

### Płaskownik

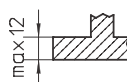

# Uchwyty kablowe - zastosowanie

## Informacje techniczne

### U-IW Montaż uchwyty U-IW

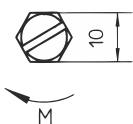
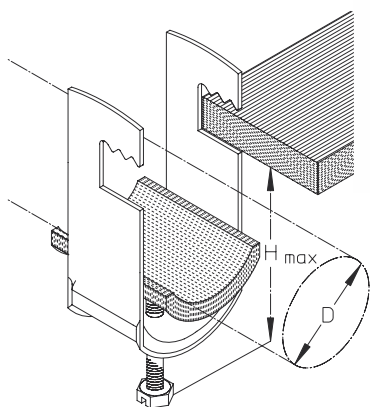

Rozmiar klucza SW 13  
Średnica  $D \geq 150$

### Płaskownik

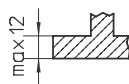

### RU Montaż uchwyty RU

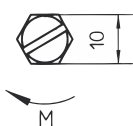
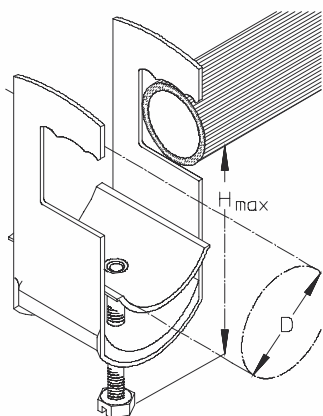

Rozmiar klucza SW 13

### Płaskownik / rura

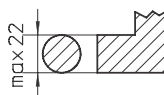





Błędy i zmiany techniczne zastrzeżone. Kopiowanie i jakiegokolwiek powielanie elektroniczne tylko za naszą pisemną zgodą. Wraz z publikacją tego dokumentu wszystkie poprzednie dokumenty tracą ważność.

