

WPTR 100

Wide-span barrier strip, height=50 mm

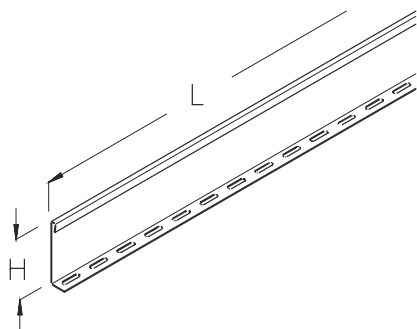

Wide-span separating strip, fastening elements included.

This article is available made in material No. 1.4571/1.4404 (V4A) stainless steel finish.

Continuously hot galvanized (Sendzimir process) (DIN EN 10346)

Product	H	L	G
WPTR 100S	50 mm	3000 mm	2,06 kg
Incl.:			
3x FRSV 6X12 3x SEMS 6		Round-head screw with short square, DIN 603 Hexagon nut, self-locking, DIN 6923	

Hot-dip galvanized, according to BS 729 (DIN EN ISO 1461)

Product	H	L	G
WPTR 100F	50 mm	3000 mm	2,20 kg
Incl.:			
3x FRSV 6X12E 3x SEMS 6E		Round-head screw with short square, DIN 603 Hexagon nut, self-locking, DIN 6923	

Stainless steel, according to ASTM 304 / BS 304 S 3

Product	H	L	G
WPTR 100E	50 mm	3000 mm	2,06 kg
Incl.:			
3x FRSV 6X12E 3x SEMS 6E		Round-head screw with short square, DIN 603 Hexagon nut, self-locking, DIN 6923	

H : Height
L : Length
G : Weight

