

RC 35

Cable tray, light, not perforated, height=35 mm

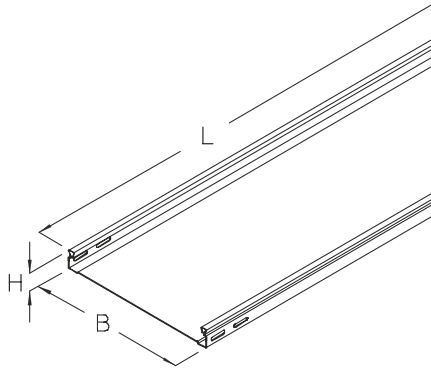

Cable tray, light, not perforated, head shape suitable for positive locking covers, with longitudinal and lateral reinforcing rims reducing bottom deflection, certified including electrical conductivity according to DIN EN 61537. Side and bottom connectors are provided for assembly.

This article is available made in material No. 1.4571/1.4404 (V4A) stainless steel finish.



Continuously hot galvanized (Sendzimir process) (DIN EN 10346)

Product	H	B	L	A	Q_{sk}	t	G
RC 35-05S	35 mm	50 mm	3000 mm	17 cm ²	0,03 kN/m	0,55 mm	1,80 kg
RC 35-10S	35 mm	100 mm	3000 mm	31 cm ²	0,05 kN/m	0,55 mm	2,40 kg
RC 35-20S	35 mm	200 mm	3000 mm	63 cm ²	0,10 kN/m	0,55 mm	3,60 kg
RC 35-30S	35 mm	300 mm	3000 mm	96 cm ²	0,15 kN/m	0,55 mm	4,80 kg

Stainless steel, according to ASTM 304 / BS 304 S 3

Product	H	B	L	A	Q_{sk}	t	G
RC 35-05E	35 mm	50 mm	3000 mm	17 cm ²	0,03 kN/m	0,55 mm	1,80 kg
RC 35-10E	35 mm	100 mm	3000 mm	31 cm ²	0,05 kN/m	0,55 mm	2,40 kg
RC 35-20E	35 mm	200 mm	3000 mm	63 cm ²	0,10 kN/m	0,55 mm	3,60 kg
RC 35-30E	35 mm	300 mm	3000 mm	96 cm ²	0,15 kN/m	0,55 mm	4,80 kg

- H** : Height
- B** : Width
- L** : Length
- t** : Material thickness
- A** : Cross section area
- Q_{sk}** : Distributed load control cable
- G** : Weight



DETAILS / APPLICATIONS

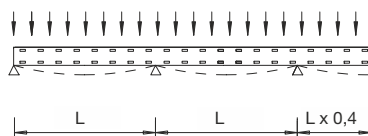
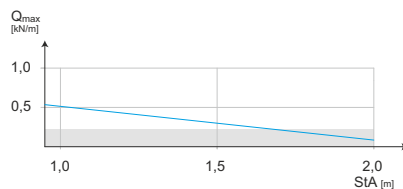
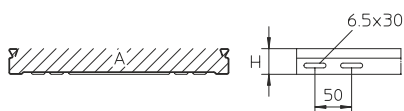
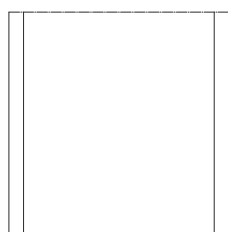

OPTIONAL ACCESSORIES

RB 35, RB45 35, RAE 35, RAA 35, RA 35, RK 35, RVB 35, RR 35, RAB 35, REB, RGV 35, RGV5, VB, RTR 35, KLR



Do not walk upon!

