

RAE 42

Cable tray attachment corner, height=42 mm

Cable tray attachment corner.

This article is available made in material No. 1.4571/1.4404 (V4A) stainless steel finish.

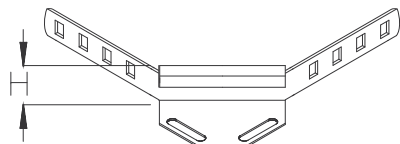

Continuously hot galvanized (Sendzimir process) (DIN EN 10346)

Product	H	G
RAE 42S	42 mm	0,18 kg

Incl.: 3x KLR	Clamp fastening set	

Hot-dip galvanized, according to BS 729 (DIN EN ISO 1461)

Product	H	G
RAE 42F	42 mm	0,21 kg

Incl.: 3x KLR E	Clamp fastening set	

Stainless steel, according to ASTM 304 / BS 304 S 3

Product	H	G
RAE 42E	42 mm	0,18 kg

Incl.: 3x KLR E	Clamp fastening set	

H : Height
G : Weight



DETAILS / APPLICATIONS

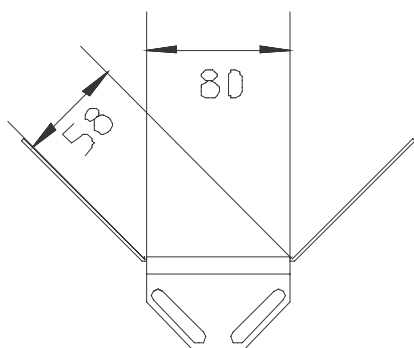

OPTIONAL ACCESSORIES

VB

